

Catálogo de tubos conexiones y herramientas

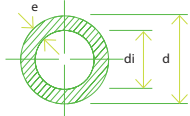

Tubos



Código	d	di	e	Área (cm ²)	Peso (kg/m)
200224	20	14.40	2.80	1.63	0.147
200225	25	18.00	3.50	2.54	0.228
200226	32	23.20	4.40	4.23	0.366
200227	40	29.00	5.50	6.60	0.568
200228	50	36.20	6.90	10.29	0.885
200229	63	45.80	8.60	16.47	1.391
200230	75	54.40	10.30	23.24	1.980
200231	90	65.40	12.30	33.59	2.850
200223	110	79.80	15.1	50.01	4.270

Cople

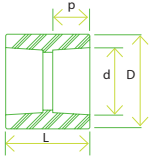

Código	d	D	p	L	Peso
200065	20	29	16	35	12
200066	25	35	18	39	15
200067	32	43	20	42	24
200068	40	53	22	49	44
200069	50	65	26	54	78
200070	63	82	30	64	141
200071	75	100	30	66	236
200072	90	120	33	72	380
200064	110	145	41	88	553

Referencias: peso de las conexiones en gramos; dimensiones en mm.

Codos 90°

Código	d	D	p	L	Peso
200014	20	29	15	27	19
200015	25	35	18	31	25
200016	32	43	19	35	41
200017	40	52	21	42	75
200018	50	64	24	50	134
200019	63	82	28	61	255
200020	75	100	29	70	455
200021	90	120	33	80	745
200013	110	145	41	95	1181

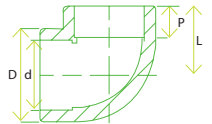

Codo macho-hembra 90°

Código	d-de	D	P	L	Peso
200037	20	30	16	27	18
200038	25	34	18	31	23

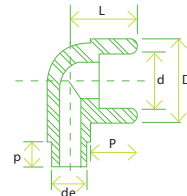

Referencias: peso de las conexiones en gramos; dimensiones en mm.

Codo 90° con rosca macho

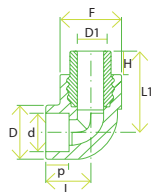

Código	d		F	D	D1	p	L	L1	H	Peso
200028	20	x	1/2	30	33	16	27	31	14	100
200029	25	x	1/2	36	40	18	30	37	14	122
200030	25	x	3/4	36	43	18	31	37	17	161
200032	32	x	1/2	43	49	20	35	47	14	171
200033	32	x	3/4	43	49	20	35	47	17	208
200031	32	x	1	43	49	20	35	47	20	296

Codo 90° con rosca hembra

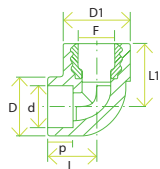

Código	d		F	D	D1	p	L	L1	Peso
200022	20	x	1/2	30	33	16	27	31	74
200023	25	x	1/2	36	40	18	30	37	86
200024	25	x	3/4	36	43	18	31	37	106
200026	32	x	1/2	43	49	20	35	47	135
200027	32	x	3/4	43	49	20	35	47	153
200025	32	x	1	43	49	20	35	47	182

Referencias: peso de las conexiones en gramos; dimensiones en mm.

Codo 45°

Código	d	D	p	L	Peso
200005	20	29	15	20	14
200006	25	35	18	23	19
200007	32	42	20	27	31
200008	40	52	22	31	54
200009	50	64	24	36	96
200010	63	82	28	44	178
200011	75	100	29	48	345
200012	90	120	33	53	565
200004	110	145	41	51	896

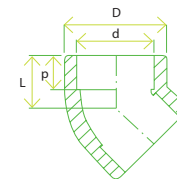

Codo macho-hembra 45°

Código	d-de	D	p	L	Peso
200034	20	30	16	20	15
200035	25	34	18	23	21
200036	32	42	20	27	33

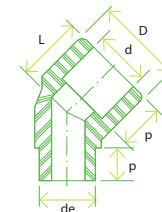

Referencias: peso de las conexiones en gramos; dimensiones en mm.

Curva 90°

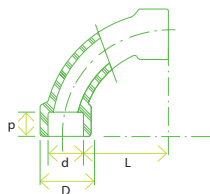

Código	d	D	p	L	Peso
200085	20	31	16	50.0	26
200086	25	47	18	62.5	38
200087	32	43	20	83.0	66

Tee

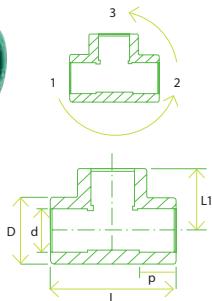

Para leer los diámetros de las Tees Tuboplus, siga esta secuencia:

- 1) Extremo de diámetro mayor
- 2) Extremo
- 3) Centro

Código	d	D	p	L	L1	Peso
200178	20	29	16	54	27	23
200179	25	35	18	63	32	32
200180	32	43	20	75	39	55
200121	40	53	22	85	43	96
200182	50	65	26	102	51	172
200183	63	82	30	122	60	318
200165	75	100	30	140	70	568
200184	90	122	33	158	75	920
200164	110	145	41	195	98	1387

Referencias: peso de las conexiones en gramos; dimensiones en mm.

Tee reducida central

Código	d1	d2	d3	D	P1	P2	L	L1	Peso	Correspondencia en pulgadas
200185	25	25	20	35	18	16	63	32	35	3/4 x 3/4 x 1/2
200186	32	32	20	43	20	16	75	39	63	1 x 1 x 1/2
200187	32	32	25	43	20	18	75	39	61	1 x 1 x 3/4
200188	40	40	25	53	22	18	85	43	114	1 1/4 x 1 1/4 x 3/4
200189	40	40	32	53	22	20	85	43	105	1 1/4 x 1 1/4 x 1
200190	50	50	32	65	26	20	102	51	201	1 1/2 x 1 1/2 x 1
200191	50	50	40	65	26	22	102	51	193	1 1/2 x 1 1/2 x 1 1/4
200192	63	63	40	82	30	22	122	60	373	2 x 2 x 1 1/4
200193	63	63	50	82	30	26	122	60	357	2 x 2 x 1 1/2
200194	75	75	50	100	30	26	140	70	428	2 1/2 x 2 1/2 x 1 1/2
200195	75	75	63	100	30	30	140	70	492	2 1/2 x 2 1/2 x 2
200196	90	90	63	122	33	30	158	75	692	3 x 3 x 2
200197	90	90	75	122	33	30	158	75	838	3 x 3 x 2 1/2

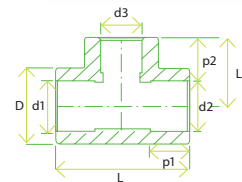

Tee reducida extrema

Código	d1	d2	d3	D	p1	p2	p3	L	L1	Peso	Correspondencia en pulgadas
200198	25	20	20	35	18	16	16	63	32	40	3/4 x 1/2 x 1/2
200200	32	20	20	43	20	16	16	75	39	83	1 x 1/2 x 1/2
200199	25	20	25	35	18	16	18	63	32	36	3/4 x 1/2 x 3/4
200202	32	25	25	43	20	18	18	75	39	74	1 x 3/4 x 3/4
200201	32	20	32	42	20	16	20	75	39	68	1 x 1/2 x 1
200203	32	25	32	42	20	18	20	75	39	69	1 x 3/4 x 1

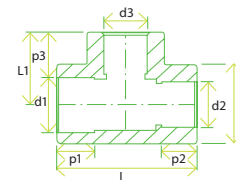

Referencias: peso de las conexiones en gramos; dimensiones en mm.

Tee reducida extrema y central



Código	d1	d2	d3	D	p1	p2	p3	L	L1	Peso	Correspondencia en pulgadas
200204	32	25	20	20	20	18	16	75	39	78	1 x 3/4 x 1/2
200205	32	20	25	20	20	16	18	75	39	77	1 x 1/2 x 3/4

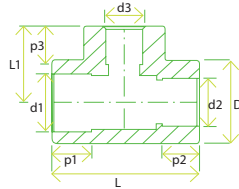

Tee con rosca central macho



Código	d	F	D	D1	p	L	L1	H	Peso
2000172	20	x 1/2	29	36	16	54	45	12	107
2000173	25	x 1/2	33	43	18	63	51	12	121
2000174	25	x 3/4	33	43	18	63	54	15	124
2000176	32	x 1/2	42	54	20	74	57	12	161
2000177	32	x 3/4	42	54	20	74	60	15	204
2000175	32	x 1	42	54	20	74	65	20	294

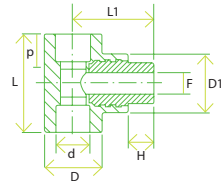

Referencias: peso de las conexiones en gramos; dimensiones en mm.

Tee con rosca central hembra

Código	d	F	D	D1	p	L	L1	Peso
2000166	20	x 1/2	29	37	16	54	33	71
2000167	25	x 1/2	33	43	18	63	39	85
2000168	25	x 3/4	33	43	18	63	39	105
2000170	32	x 1/2	42	54	20	74	44	127
2000171	32	x 3/4	42	54	20	74	44	149
2000169	32	x 1	42	54	20	74	44	180

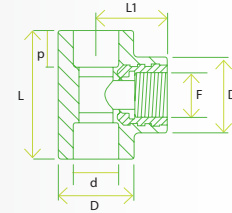

Cruz

Código	d	D	p	L	Peso
200082	20	27	16	54	20

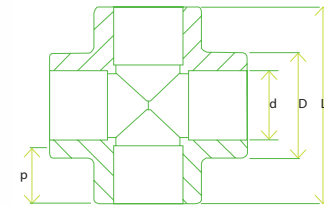

Referencias: peso de las conexiones en gramos; dimensiones en mm.

Conectores Rectos

Conector macho



Código	d		f	D	D1	p	L	H	E	Peso
200051	20	x	1/2	27	38	16	53	12		95
200052	20	x	3/4	32	41	17	60	18		150
200053	25	x	1/2	36	41	17	62	15		106
200054	25	x	3/4	36	41	17	65	18		148
200056	32	x	3/4	43	48	19	73	18		180
200055	32	x	1	43	48	19	75	20		270
200057	40	x	1¼	53	66	21	92	20	22	510
200058	50	x	1½	58	74	24	97	22	20	585
200059	63	x	2	78	85	29	102	20	22	744
200060	75	x	2½	100	109	31	108	21	77	1926
200061	90	x	3	120	128	34	115	27	90	1503

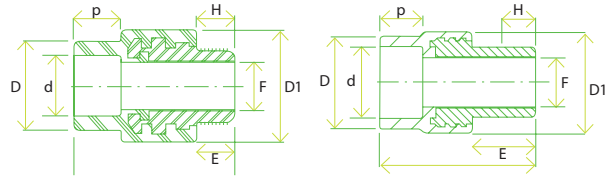

Referencias: peso de las conexiones en gramos; dimensiones en mm.

Conector hembra

Código	d		F	D	D1	p	L	H	E	Peso
200039	20	x	1/2	27	41	16	53	12		59
200040	20	x	3/4	32	41	17	42	16		96
200041	25	x	1/2	36	41	17	47	12		69
200042	25	x	3/4	36	41	17	47	16		94
200044	32	x	3/4	43	47	19	55	17		125
200043	32	x	1	43	48	19	55	17		157
200045	40	x	1¼	53	67	21	70	22	20	408
200046	50	x	1½	64	73	25	75	24	20	481
200047	63	x	2	78	85	29	80	24	20	613
200048	75	x	2½	100	109	31	84	22	82	945
200049	90	x	3	120	128	34	91	25	95	1204

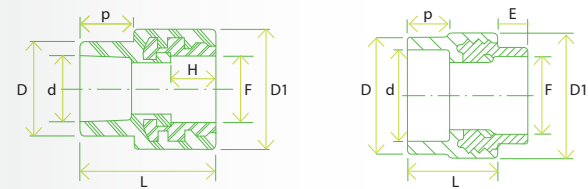

Referencias: peso de las conexiones en gramos; dimensiones en mm.

Conector macho con espiga para Termofusión



Código	d	F	D	D1	p	L	H	Peso	
200062	20	x	1/2	20	38	16	531	12	94

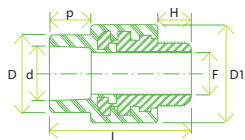

Conector hembra con espiga para Termofusión

Código	d	F	D	D1	p	L	H	Peso	
200050	20	x	1/2	20	38	16	53	12	58

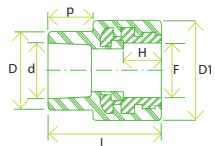

Referencias: peso de las conexiones en gramos; dimensiones en mm.

Reducción

Código	d1	d2	D	p	L	Peso
200140	25	20	29	16	39	11
200141	32	20	29	18	44	21
200142	32	25	35	18	46	18
200143	40	25	35	18	48	26
200144	40	32	43	20	48	27
200145	50	32	43	20	56	41
200146	50	40	52	22	56	50
200147	63	40	52	22	64	75
200148	63	50	64	25	64	86
200149	75	50	64	22	68	119
200150	75	63	82	29	74	173
200151	90	63	82	29	78	186
200152	90	75	100	29	82	264

Código	d1	d2	D1	D2	P1	P2	L	Peso
200136	110	50	145	66	41	23	72	438
200137	110	63	145	82	41	26	75	470
200138	110	75	145	98	41	31	81	508
200139	110	90	145	119	41	38	88	562

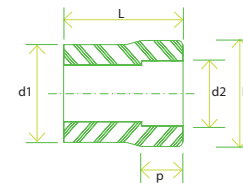
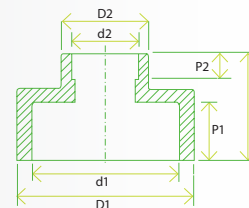

Referencias: peso de las conexiones en gramos; dimensiones en mm.



Tuercas

Tuerca unión



Código	d	D	E	L	p	Peso
200232	20	29	44	46	16	93
200233	25	34	47	49	17	132
200234	32	43	66	50	19	232

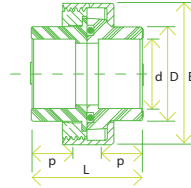
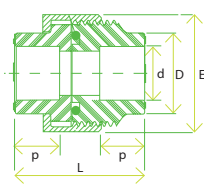

Tuerca unión mixta



Código	d	F	D	L	D1	E	E1	Peso	P
200235	20	x 1/2	29	43	46	42	27	181	16
200236	25	x 3/4	34	51	51	47	32	236	18
200237	32	x 1	42	49	68	64	41	434	20

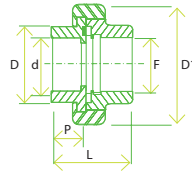
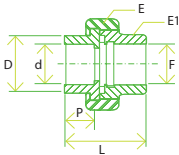

Referencias: peso de las conexiones en gramos; dimensiones en mm.

Tuerca unión plástica*

Código	d	D	D1	D2	L	Peso
200377	20	30	50	30	46	41
200378	25	35	55	34	50	48
200379	32	43	67	43	50	72

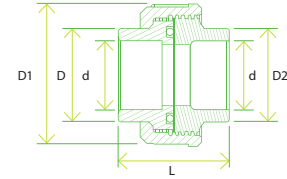

Tuerca unión plástica mixta*

Código	d	D	D1	D2	L	R	Peso
200381	20	x	30	50	32	49	1/2" NPT 41
200380	25	x	35	55	38	53	3/4" NPT 50
200382	32	x	43	67	46	59	1" NPT 79

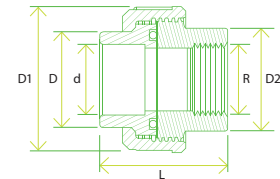

*Producto exclusivo para viviendas.

Referencias: peso de las conexiones en gramos; dimensiones en mm.

Uniones

Unión bridada

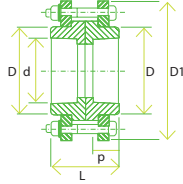

Código	d	D	p	L	D1	Peso
200238	40	53	22	53	96	752
200238	50	67	25	60	108	780
200238	63	84	28	66	138	1079
200238	75	100	30	80	160	2800
200238	90	122	33	90	180	3200
200238	110	138	43	112	200	3800

Unión bridada mixta

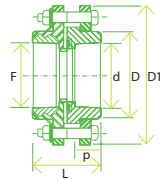

Código	d		F	D	p	L	D1	Peso
200249	40	x	1 ¼	53	22	60	96	980
200244	50	x	1 ½	67	25	64	108	1085
200245	63	x	2	84	28	67	138	1475
200246	75	x	2 ½	100	30	76	160	3400
200247	90	x	3	122	33	78	180	4000
200248	110	x	4	138	43	98	200	4450

Referencias: peso de las conexiones en gramos; dimensiones en mm.

Tapón

Código	d	D	p	L	Peso
200155	20	30	16	20	9
200156	25	33	18	23	12
200157	32	42	20	26	20
200158	40	52	22	30	41
200159	50	66	27	35	75
200160	63	83	32	42	142
200161	75	100	29	60	250
200162	90	120	33	68	391
200154	110	145	41	75	560

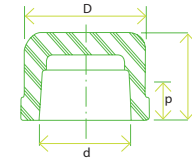

Montura de derivación o silleta

Código	Tubo	d	D1	D2	p	R	L1	L2
200121	63	20	28	25	16	32	28	37
200123	75	20	28	25	16	38	28	39
200126	90	20	28	25	16	45	28	41
200117	110	20	28	25	16	55	28	45
200122	63	25	34	25	18	32	31	39
200124	75	25	34	25	18	38	31	42
200127	90	25	34	25	18	45	30	43
200118	110	25	34	25	18	55	30	47
200125	75	32	43	33	20	38	34	46
200128	90	32	43	33	20	45	34	48
200119	110	32	43	33	20	45	34	51

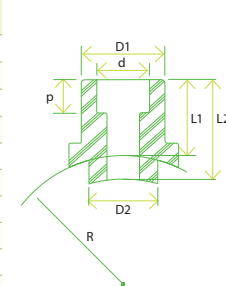

Referencias: peso de las conexiones en gramos; dimensiones en mm.

Válvulas

Válvulas de Esfera PP-R

nuevo



Código	d	D	p	a	L	L1	Peso
200360	20	29	18	15	77	45	0.11
200361	25	36	18	18	79	49	0.16
200362	32	44	20	23	88	57	0.25
200363	40	55	21	32	103	65	0.41
200364	50	69	23	38	115	80	0.79
200365	63	87	27	42	132	82	1.19
200366	75	95	32	47	165	97	1.78
200367	90	113	35	56	185	113	2.71
200368	110	138	41	68	220	123	4.37

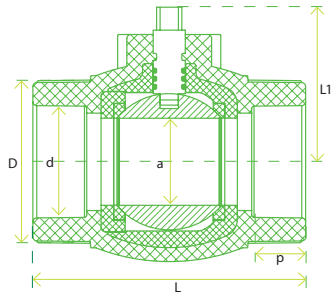

Referencias: peso de las conexiones en gramos; dimensiones en mm.

Válvulas de Globo PP-R

nuevo



Código	d	D	p	a	L	L1	Peso
200369	20	28	16	13	67	74	0.15
200370	25	34	17	17	78	81	0.24
200370	32	43	20	17	80	84	0.26
200370	40	52	22	21	95	95	0.41
200370	50	66	25	26	111	114	0.62
200370	63	82	26	31	121	121	0.86

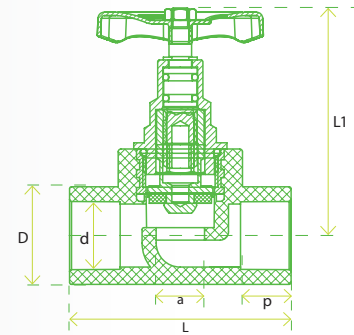

Referencias: peso de las conexiones en gramos; dimensiones en mm.

Llave de empotrar para regadera



Código	d	D1	D2	p	L	L1	L2	Peso
210136	20	27	38	16	95	35	64	155

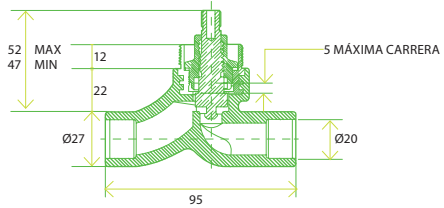

Válvula de esfera

Código	d	D	p	L	L1	Peso
200250	20	37	16	96	94	55
200251	25	42	18	96	94	49

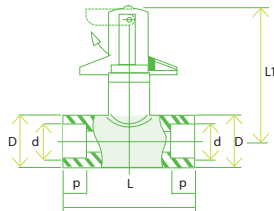

Referencias: peso de las conexiones en gramos; dimensiones en mm.

Válvula de esfera desmontable

Código	d	D	D1	p	L	Peso
200252	20	26	42	12	82	300
200253	25	34	50	16	94	425
200254	32	42	60	18	105	675
200255	40	52	73	21	127	1150
200256	50	65	91	23	147	1850
200257	63	82	115	28	169	3050

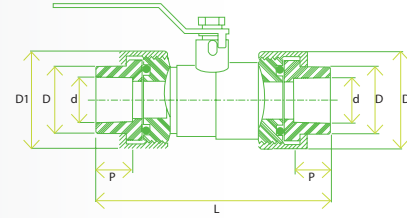

Referencias: peso de las conexiones en gramos; dimensiones en mm.

Conectores plásticos

Conector macho*



Código	Descripción	Dimensiones
200305	Conector macho de 20 mm	x 1/2"
200309	Conector macho de 25 mm	x 3/4"

Conector hembra*



Código	Descripción	Dimensiones
200304	Conector hembra de 20 mm	x 1/2"
200310	Conector hembra de 25 mm	x 3/4"

Codos plásticos

Codo macho*



Código	Descripción	Dimensiones
200307	Conector macho a 90°	20 mm x 1/2"
200308	Conector macho a 90°	25 mm x 3/4"

Codo hembra*



Código	Descripción	Dimensiones
200306	Conector hembra a 90°	20 mm x 1/2"
200321	Conector hembra a 90°	25 mm x 3/4"

*Producto exclusivo para viviendas.

Conector a cobre

Código	Descripción	Dimensiones
200279	Conector rápido a cobre 20x1/2"	20x1/2"



Tijeras corta tubos

Código	Descripción	Dimensiones
200214	Tijera hasta 32 mm	20/32



Código	Descripción	Dimensiones
200216	Tijera cortatubo 40 mm Heavy Duty	20/40



Código	Descripción	Dimensiones
200261	Corta tubo hasta 125 mm	20/125 mm



Código	Descripción	Dimensiones
200215	Tijera hasta 63 mm	20/63



Termofusores



Termofusor RJQ 32	Código	Descripción	Dimensiones	Embalaje
120 V - 600 W	200282	Kit con dados 20-25	20/32	Caja de cartón



Termofusor RJQ 63	Código	Descripción	Dimensiones	Embalaje
120 V - 800 W	200110	Kit con dados 20-25	20/63	Caja metálica



Termofusor RJQ 110	Código	Descripción	Dimensiones	Embalaje
120 V - 1000 W	200208	Kit sin dados	20/110	Caja metálica

Dados



Código	Descripción	Dimensiones
200092	(M-H) 20 con ranura	20
200093	(M-H) 25 con ranura	25
200094	(M-H) 32	32
200095	(M-H) 40	40
200096	(M-H) 50	50
200097	(M-H) 63	63
200098	(M-H) 75	75
200099	(M-H) 90	90
200091	(M-H) 110	110

Dado de reparación



Código	Descripción	Dimensiones
200107	Dados para reparación de perforaciones	8 mm

Dados para monturas de derivación

Código	Descripción	Dimensiones
200102	Dados	63 x 20/25
200103	Dados	75 x 20/25
200105	Dados	90 x 20/25
200100	Dados	110 x 20/25
200104	Dados	75 x 32
200106	Dados	90 x 32
200101	Dados	110 x 32



Tapón de reparación



Código	Descripción	Dimensiones
200280	Tapón de PP-R	8 mm